

- A. Introduction
- B. Safety Rules
- C. International Electrical Symbols
- D. Feature
- E. Specification
- F. Operation Plate
- G. Make Measurement
- H. Fuse and battery replacement
- I. Accessories

Remark:

The model of UT30B,UT30C,UT30D will be marked as UT30BL,UT30CL,UT30DL,if they have backlight function.



Model UT30B/C/D/F: OPERATING MANUAL
Summary of UT30 Series DMM

A. Introduction

UT30 series Multimeter is 3 1/2 digits with steady operations, fashionable structure and highly reliable hand-held measuring instrument. The meter can measure DC/AC voltage, DC/AC current, Resistance, Frequency, Temperature, Diode, Transistor hFE, and Continuity. It is an ideal tool for maintenance.

CAUTION-FOR CONTINUED PROTECTION AGAINST FIRE, REPLACE ONLY WITH FUSE OF THE SPECIFIED VOLTAGE AND CURRENT RATINGS.

- 1 Do not operate the meter unless the bottom case has been closed as terminal can carry voltage.
- 1 Inspect the insulation of the test leads and make sure there is no damage to the test leads before using the meter.
- 1 As soon as the battery indicator's "⊕±" appear, replace the battery to ensure accurate readings.
- 1 Set the meter to suitable function and range before each measurement.
- 1 Tested values over the maximum range of each measurement can cause damages to the meter or electric shock to users.
- 1 To avoid damages of the meter, do not turn the rotary switch during measurement.
- 1 When measuring voltage higher than DC 60V or AC 30Vrms, pay extra attention to avoid electric shock.













B. Safety Rules(2)

- 1 Make sure to replace right type and right rating fuse.
- 1 Do not operate or store the Meter under high temperature or humid condition.
- 1 Do not change internal circuit to avoid damages to the meter and danger to the user.
- 1 Periodically wipe the case with damp cloth and mild detergent. Do not use abrasives and solvents.
- 1 The meter is designed to withstand the stated maximum voltages. If it's not possible to exclude, without doubts, that impulses, transients, disturbance or for other reasons these voltages are exceeded, a suitable prescaler (1:10) must be used.

Model UT30B/C/D/F: OPERATING MANUAL
C. International Electrical Symbols

UNI-T®

	Low Battery		Earth Ground
	Warning		Double Insulation
	AC current		Diode
	DC current		Buzzer
	Fuse		AC or DC

D.General Specifications(1)

1. The maximum voltage, between any terminal and earth, is 600Vrms.
 - A . The“COM”input terminal is always connected with the black test lead.
 - B . The“V,ohm, mA”input terminal is always connected with the red test lead and is used to measure voltage up to 500V,resistance and current up to 200mA.
 - C . The“10A MAX”input terminal is always connected with the red test lead and is used to measure current greater than 200mA but no more than 10A.
2. ⚠ 10A Terminal: non-fused
3. ⚠ mA Terminal Fuse: \varnothing 5x20-0.3A 250V.(Fast)
4. Maximum Display is 1999,and updates two or three times every second.
5. Over range display is “1” or “OL”. (Only UT30F).

6. Temperature:
Operating: 0°C-40°C (32 °F-104 °F)
Storing:-10°C-50°C (14 °F -122 °F)
7. Altitude:
Operating:2000m
Storage:10000m
8. Relative humidity:Max.relative humidity 80% for temperature up to 31°C decreasing linearly to 50% relative humidity at 40°C.
9. Battery: 9V NEDA 1604 or 6F22 or 006P.
10. Low Battery Indication: Display “”.on LCD.
11. Dimension:75mmx130mmx36mm
12. Weight: approx. 150g(Test Leads not included)

Accuracy: \pm (a% reading + b digit), which guarantee one year.

Environmental Temperature: $23\text{ }^{\circ}\text{C} \pm 5^{\circ}\text{C}$

Relative Humidity: <75%

1. DC Voltage

Range	Resolution	Accuracy			
		UT30B	UT30C	UT30D	UT30F
200mV	100 μ V	$\pm(0.5\%+2)$			
2000mV(2V)	1mV				
20V	10mV				
200V	100mV				
500V	1V	$\pm(0.8\%+2)$			

 Input Impedance: $10\text{M}\Omega$ for all the ranges.

Overload protection: At 200mV range, it's protected at 230V(AC / DC Current), others are protected at 500V(AC or DC).

2. AC Voltage

Range	Resolution	Accuracy			
		UT30B	UT30C	UT30D	UT30F
200mV	100 μ V	-----			$\pm(1.2\%+3)$
2V	1mV				$\pm(1\%+3)$
20V	10mV				
200V	100mV	$\pm(1.2\%+10)$			$\pm(1.2\%+3)$
500V	1V				

⚠ Input Impedance: (approx. 5M Ω) of UT30B\C\D, but all ranges of UT30F are 10M Ω .

Frequency: 40-400Hz

Display: RMS of Sine Wave Value (Average Value)

Overload protection: At 200mV range, it is protected at 230V(AC / DC Current), others are protected at 500V(AC or DC)

3. DC Current

Range	Resolution	Accuracy			
		UT30B	UT30C	UT30D	UT30F
200μA	100nA		-----		
2000μA(2mA)	1μA		±(1%+2)		
20mA	10μA				
200mA	100μA	±(1.2%+2)			
10A	10mA	±(2%+5)			

⚠ Overload Protection: 0.3A/250V fuse, No fuse at 10A, measuring time limit is equal to or less than 10 seconds, and time interval should be equal to or over 15 minutes.

Measuring voltage drop: Full range is 200m V.

4. AC Current(Only UT30F)

Range	Resolution	Accuracy
200mA	100 μ A	$\pm(1.8\%+3)$
10A	10mA	$\pm(3\%+7)$

⚠ Overload Protection: 0.3A/250V fuse, No fuse at 10A, measuring time limit is equal to or less than 10 seconds; time interval is equal to or over 15 minutes.

Frequency response: 40Hz-400Hz

Display: RMS of Sine Wave Value (Average Value)

5. Resistance

Range	Resolution	Accuracy			
		UT30B	UT30C	UT30D	UT30F
200Ω	0.1Ω	±(0.8%+5)			
2000Ω(2kΩ)	1Ω	±(0.8%+2)			
20kΩ	10Ω				
200kΩ	100Ω				
2MΩ	1kΩ	-----			
20MΩ	10kΩ	±(1%+5)			

 Overload Protection: All ranges are 230V(DC/ AC current).

6. Temperature(Only UT30C)

Range	Resolution	Accuracy
-40 °C~150 °C	1 °C	± (1%+3)
150 °C~1000 °C	1 °C	± (1.5%+15)

⚠ Overload Protection: 230V(DC /AC current)
Temperature Transducer: International Standard K type
Thermocouple (Nichrome -Nickel silicon)

7. Frequency(Only UT30F Auto Range)

Range	Resolution	Accuracy
2kHz~10MHz	1Hz~10kHz	±(0.1%+3)

⚠ Overload Protection: 230V(AC / DC current)

Input Sensitivity: (10Hz- 1MHz) ≤ 500m V;
(1MHz-10MHz) ≤ 1V.



MAX input scope ≤ 10V.

8. Square Wave Output(Only UT30D)

Range	Illustration
OUT	Output approx. at 50Hz Square Wave .As a simple signal source , with 100kΩ resistance output.

⚠ No overload protection for this range; make sure voltage output of calibrated equipment is less than 10V to avoid damages to the Meter.

9. Diode, Transistor, Continuity Beeper Test

Function	Range	Resolution	30B	30C	30D	30F	Remark
Diode		1mV	✓	✓	✓	✓	Display voltage drop approximation.
Transistor	hFE	1β	✓	✓	✓	✓	I _{bo} ≈ 10μA V _{ce} ≈ 3V
Continuity Beeper Test		1Ω		✓	✓	✓	others ≤ 70Ω Buzzer sound

⚠ Overload Protection: 230V(DC/ AC current),Only \rightarrow \rightarrow \rightarrow)

Operation Plate(see figure 1)

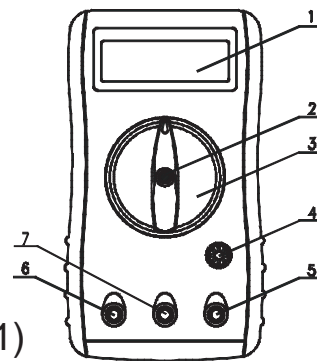

1. Liquid Crystal Display
2. Data hold or backlight selection button
except UT30F(AC/ DC exchange)*
3. Rotary Switch
4. Transistor Test Jack
5. Common Input Jack
6. 10A Input Jack
7. Input Jack for General Measurement



(figure 1)

* If the model has backlight function as UT30BL,UT30CL,UT30DL,
press the button abidingly over 3 seconds,backlight will be opened, it
will shut off automatically after 20 seconds late.

G.Make Measurements(1)

First, set rotary switch to proper position. When the battery is low, “” will appear on LCD. Second, the “” symbol beside the input jack warns you when testing current and voltage. Input values must not exceed the limit.

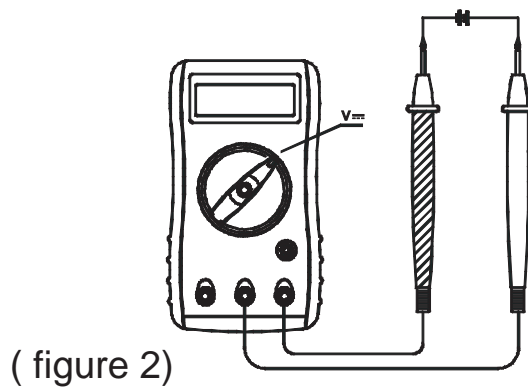
1.DC Voltage Measurement(see figure 2)

G.Make Measurements(2)

- 1) Never measure voltage value exceeding 500V, although it is possible to get the reading. This may cause damages to the internal circuit and danger to users;
- 2) Set rotary switch to maximum range, if the voltage value to be tested is unknown. Then according to reading requirement adjust to a lower range until satisfactory reading is obtained.
- 3) If “1” or “OL” is shown on LCD, set to the higher range because the selected range is overloaded.
- 4) At every range, input impedance is 10M Ω . This can cause measuring tolerance at high impedance, If circuit impedance is equal to or less than 10k Ω , you can ignore the tolerance(0.1% or lower).

G. Make Measurements(3)

2. AC Voltage Measurement (see figure 3)

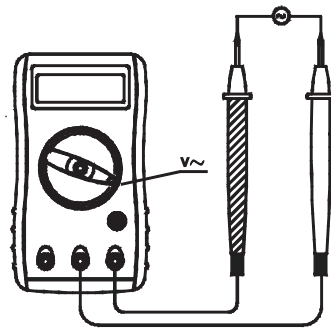

(figure 3)

⚠ Same as DC voltage measurement.

3. DC Current Measurement(see figure 4)

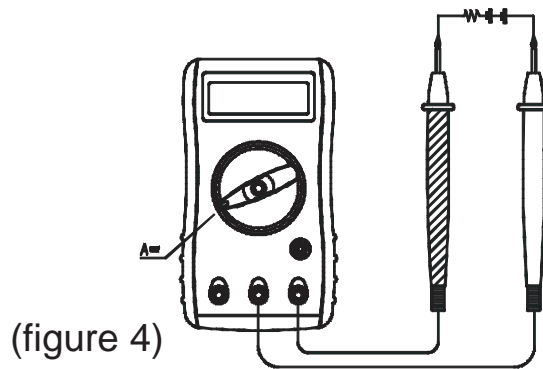

- 1) Do not measure when value between open voltage and earth is exceeding safety voltage 60V because it may cause damages to the measuring object or instrument and also hurt the user.

G.Make Measurements(5)

- 2) Before measurement, cut off the power to the object to be measured and inspect if input terminal or rotary switch is set to the right range then you can measure the object with power on.
- 3) If the magnitude of current is unknown, set rotary switch to the highest range and then adjust to a lower range until a satisfactory reading is obtained.
- 4) If the meter is overloaded on mA input jack the fuse will melt up. In this case, replace with a new fuse with same specification.
- 5) The dimension of fuse is $\varnothing 5 \times 20$ (mm)and the specification is F.0.3A/250V (FAST).
- 6) For 10A input jack, it is non-fused. For safety, each measuring time should be equal to or less than 10 seconds. Time intervals should be equal to or over 15 minutes.

4. AC Current Measurement(Only for UT30F)(see figure 5)

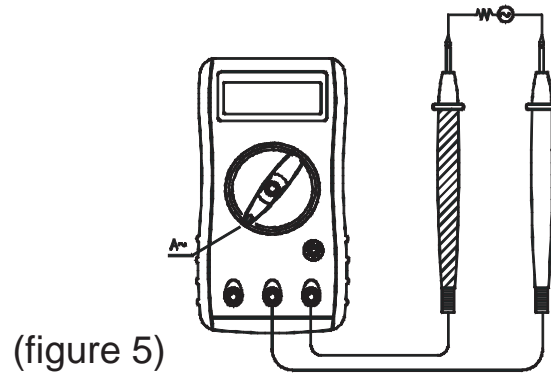

⚠ Same as DC current measurement

5. Resistance Measurement (see figure 6)

- 1) To avoid damages to the Meter when measuring resistance, cut off the power of the object and make sure there is no charge in capacitor.
- 2) Test lead wires take 0.1Ω - 0.3Ω tolerance when measuring resistance. To get an accurate reading, subtract the short circuit values of the 2 test leads.
- 3) It will take several seconds for the display to become stabilized when resistance value is over $1M\Omega$.

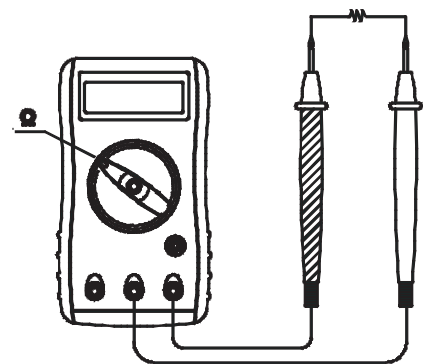

(figure 6)

6. Diode measurement (see figure 7)

- 1) Avoid damages to the meter. When measuring diode, cut off the power supply of the object and make sure there is no charge in capacitor.
- 2) When measuring voltage drop of diode, transistor, and other semiconductor component at diode function, its silicon semiconductor structure should be normal positive reading and stay between 0.5V and 0.8V. Negative display being "1" means open circuit; when the red test lead is positive pole and the black one is negative pole.

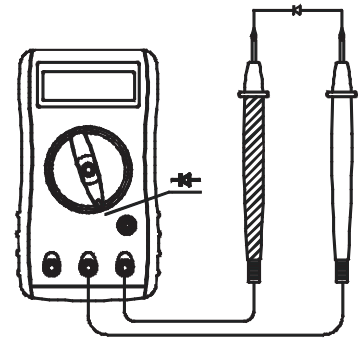

(figure 7)

7. Transistor hFE Measurement (see figure 8)

- 1) Check that the transistor is PNP or NPN type.
- 2) Connect the transistor to be measured to the corresponding jacks.
- 3) LCD display hFE reference value.
- 4) Measuring condition: $I_{BO} \approx 10\mu A$, $V_{CE} \approx 3V$

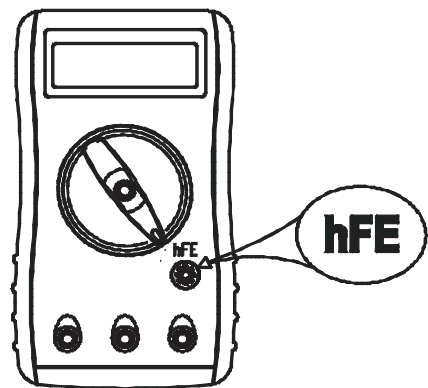

(figure 8)

8. Temperature Measurement:(Only for UT30C)(see figure 9)

- 1) Insert the black **K** type thermocouple (P/N:41700103) into “COM” socket. Red lead of temp. probe into “°C” socket, LCD displays the measuring value with unit in °C.
- 2) The temperature probe limits to below 250°C. For a higher degree of temperature measurement, use another hand-held thermocouple (P/N:41700107). The LCD display room temperature when unloading the probe.

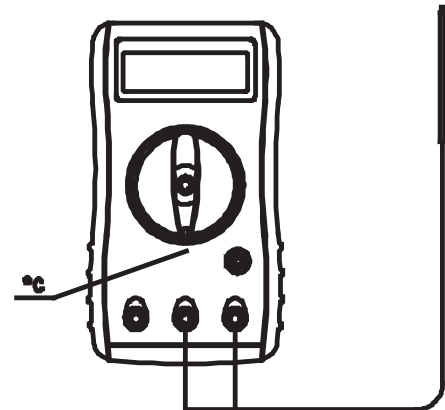

(figure9)

9. Square Wave Output:(Only UT30D) (see figure 10)

- 1) To avoid damages to the meter, do not let output terminal reach higher then 10V voltage.
- 2) The frequency is 50Hz.
- 3) The output voltage range will be over 3V when it is loaded 1M Ω .
- 4) Use square wave output to repair audio equipment.

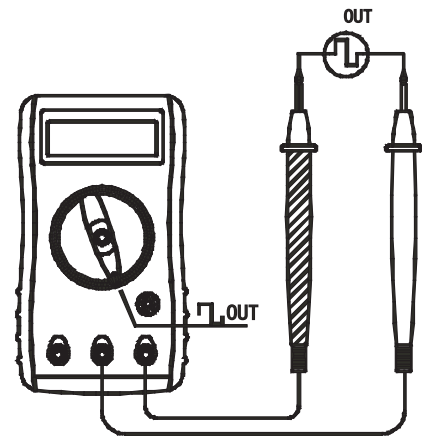

(figure10)

10. Frequency Measurement (Only for UT30F)(see figure 11)

- 1) Do not input voltage over 230V RMS to avoid damages to the meter.
- 2) The LCD will display reading when the measured frequency is more than 10V, but the read out may exceed specification. To obtain an accurate, stable reading, an external attenuator should be used.
- 3) To measure high frequency signal in high interferenced environment use shielded cable.

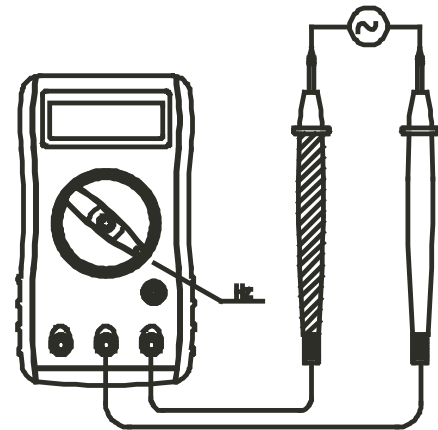

(figure11)

H. Fuse and battery replacement(see figure 12)

- 1) Turn the rotary switch to OFF position, and remove the test leads from terminals.
- 2) Remove two rubber feet and two screws from the bottom case.
- 3) Separate the bottom case from the top case.
- 4) Replace the battery or fuse with in user's manual specification.
- 5) Rejoin the bottom case and top case, and reinstall two screws and two rubber feet.

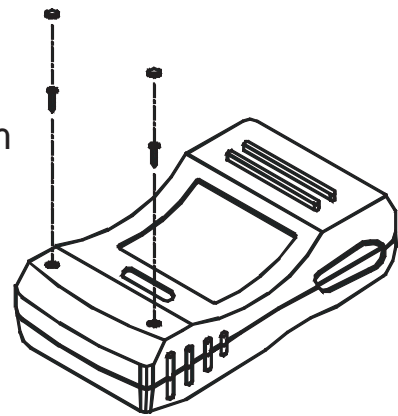

(figure12)



Model UT30B/C/D/F: OPERATING MANUAL

I.Accessories

- 1) Operating manual
- 2) Test leads
- 3) Thermocouple(Only for UT30C)

**** END ****

This operating manual is subject to change without notice.

Model UT30B/C/D/F: OPERATING MANUAL

UNI-T®



Model UT30B/C/D/F: OPERATING MANUAL

©Copyright 2001 Uni-Trend International Limited.
All rights reserved.

Manufacturer:
Uni-Trend International Limited
Rm901, 9/F, Nanyang Plaza
57 Hung To Road
Kwun Tong
Kowloon, Hong Kong
Tel: (852) 2950 9168
Fax: (852) 2950 9303
Email: info@uni-trend.com
<http://www.uni-trend.com>