



SITTZ

COLEÇÃO

SITTZ

ambiente

seu

ambiente

SITTZ

Sittz

Bariri - SP  
contato@sittz.com.br  
www.sittz.com.br

+55 14 3662-9000



# COLABORATIVO

S:ITZ



FLOW MOD

S:ITZ



FLOW MOD  
DESCRIÇÕES

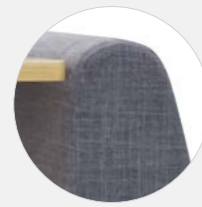

1. Encosto anatômico em espuma de alta densidade.

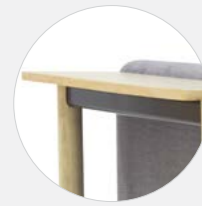

3. Mesa de apoio com tampo em madeira natural.



5. Pés em madeira natural com encaixe para suporte da estrutura.



2. Assento anatômico em espuma de alta densidade.

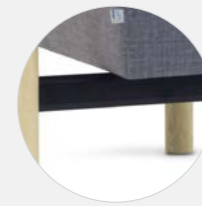

4. Suporte metálico de sustentação e fixação dos pés.

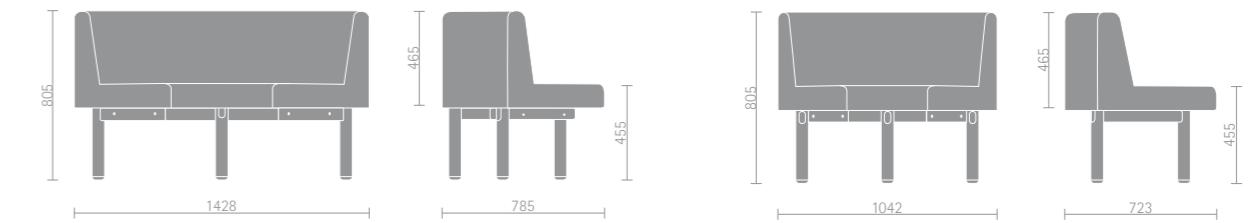
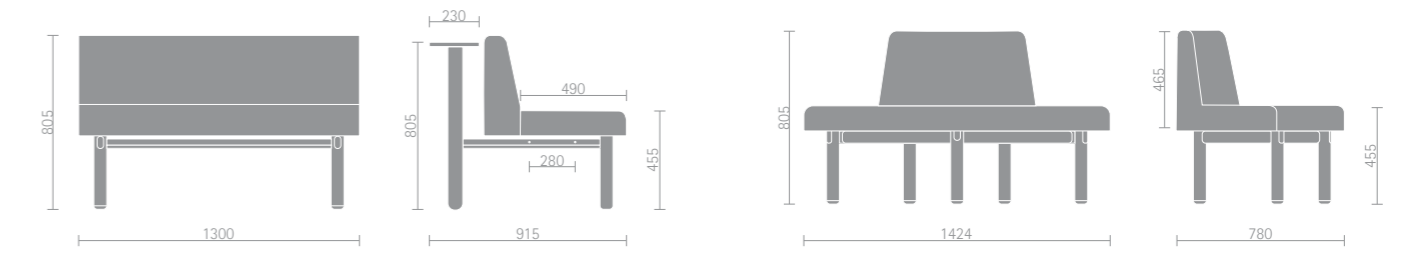
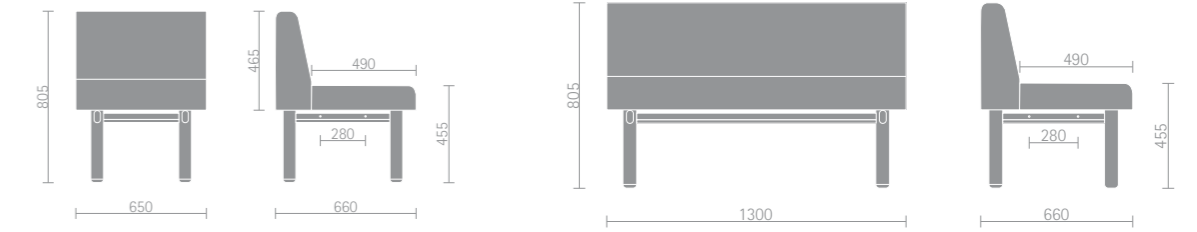

Medidas nominais para referência, podem ocorrer variações.



S:ITZ



FLOW TALK

S:ITZ



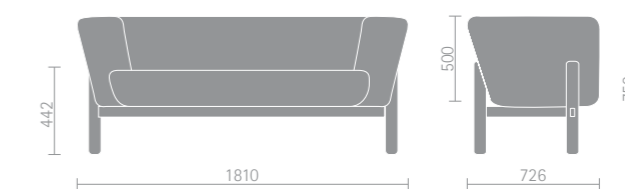
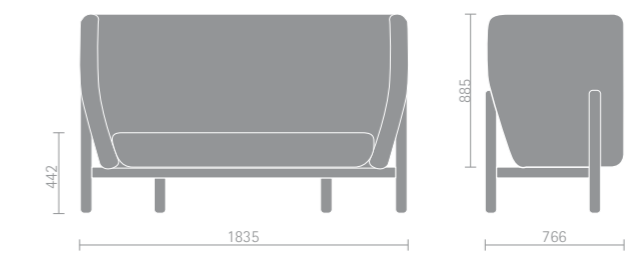

S:ITZ

FLOW

S:ITZ



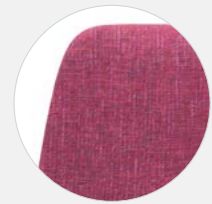

1. Concha em espuma injetada de alta densidade, com percintas elásticas.



3. Base fixa em alumínio polido.



2. Mecanismo Oscilante, que permite movimento de inclinação da concha e giratório.

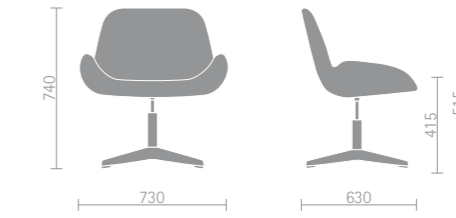
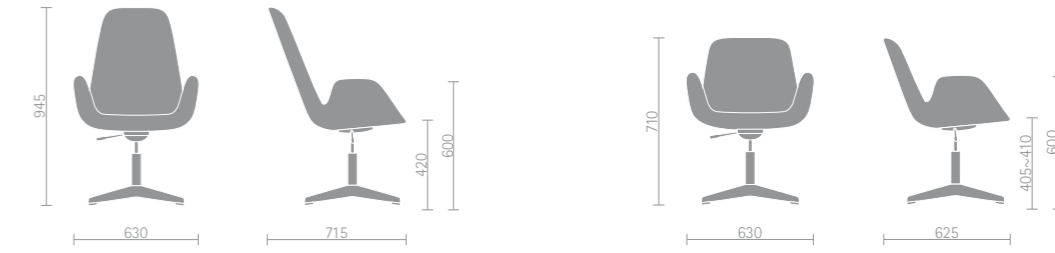



S:ITZ

HONEY

S:ITZ



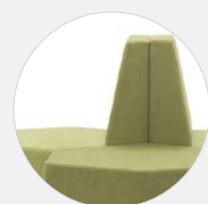

1. Estrutura interna em madeira com espuma e revestimento.

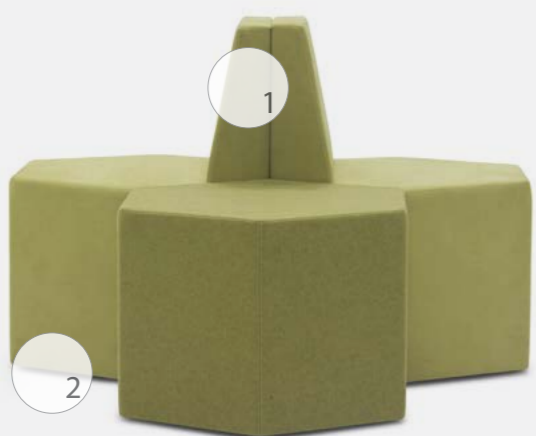

2. Sapatas fixa PU incolor.

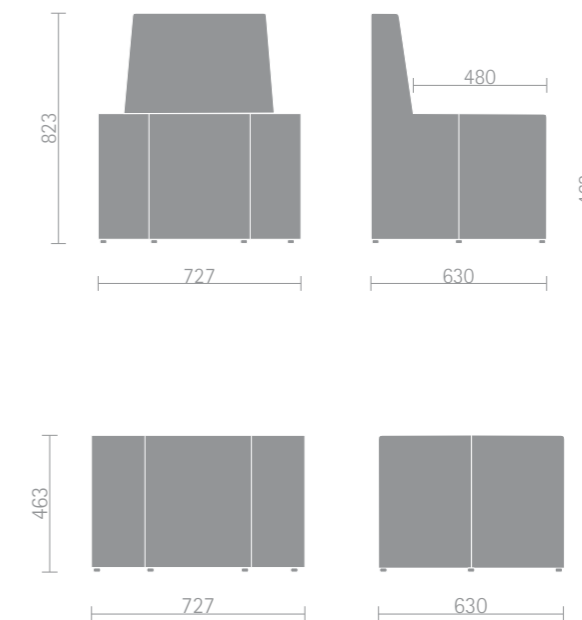

S:ITZ

WOMA

S:ITZ



# WOMA

## DESCRIÇÕES



### BASE

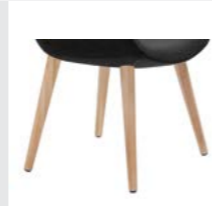

Pés - Madeira

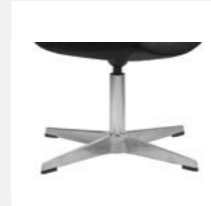

Base - Alumínio

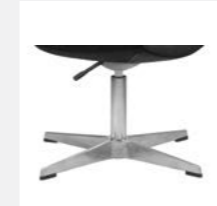

Base-Alumíniocomflange

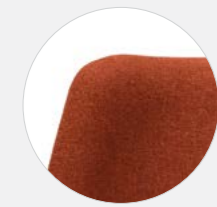

1. Concha em espuma injetada e revestida, com percintas que permitem maior conforto.



3. Base fixa em alumínio polido.

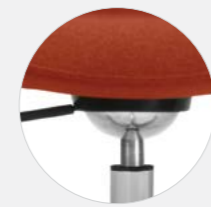

2. Mecanismo Oscilante, que permite movimento de inclinação da concha e giratório.

## COMPONENTES WOMA

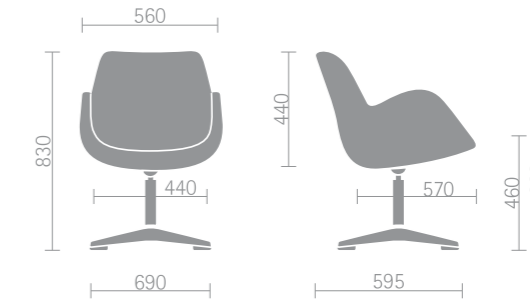
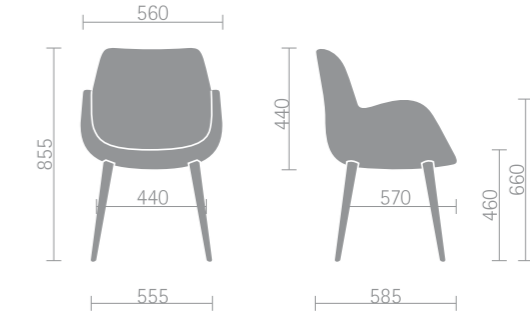

# EXECUTIVO

The logo for SITIZ, featuring the word "SITIZ" in a bold, sans-serif font. The letter "I" is highlighted in a light green color, while the other letters are in a dark grey color.

S:ITZ

TIME

S:ITZ



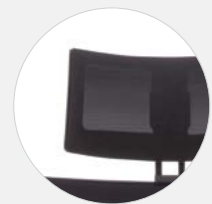

1. Encosto de cabeça articulado, elaborado em Polipropileno e tela.



3. Encosto em tela que permite troca térmica. Opções de cores: preto, vermelho e cinza.

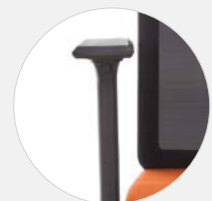

5. Braço com ajuste de altura, múltiplos pontos de parada, em Polipropileno.



7. Base em Nylon ou Alumínio com design piramidal.



2. Porta paletô agregado ao encosto.

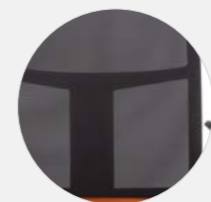

4. Sistema Up Down: regulagem de apoio lombar para encosto.

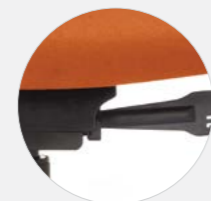

6. Mecanismo Synchron com 4 estágios de parada e sistema de tensão auto ajustável.

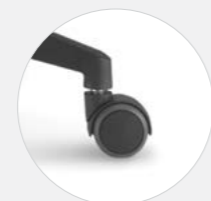













8. Rodízio em PU ou Nylon.

## TIME

### DESCRIÇÕES



<b>BASE</b>	 Basepiramidal-Alumínio	 Base piramidal - Nylon		
<b>MECANISMO</b>	 MecanismoSynchron-Auto			
<b>BRAÇO</b>	 Braço com regulagem-PP			
<b>RODÍZIO</b>	 Rodízio - Nylon	 Rodízio - PU		
<b>MECANISMO</b>	 Flange simples	 Mec.contatopermanente		
<b>BASE</b>	 Base piramidal - Nylon	 Basemetalíca com capa PP	 Base arcada - Nylon	 Estrutura fixa - Preta

## COMPONENTES TIME

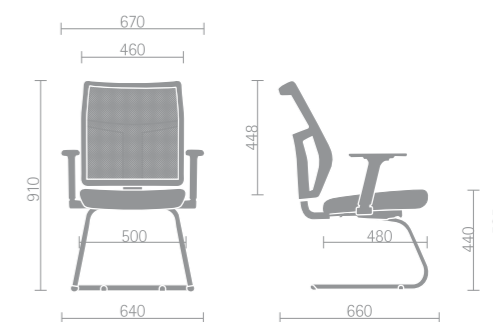
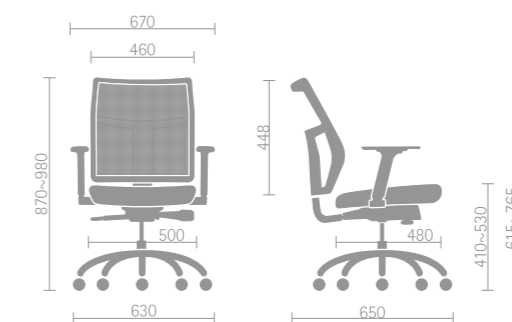
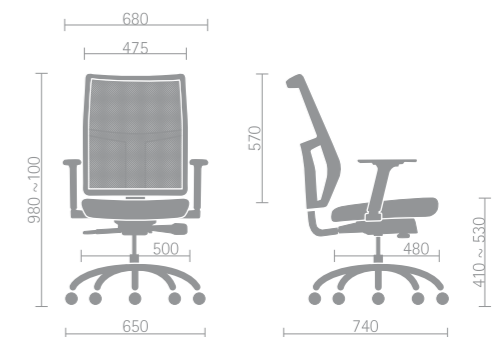
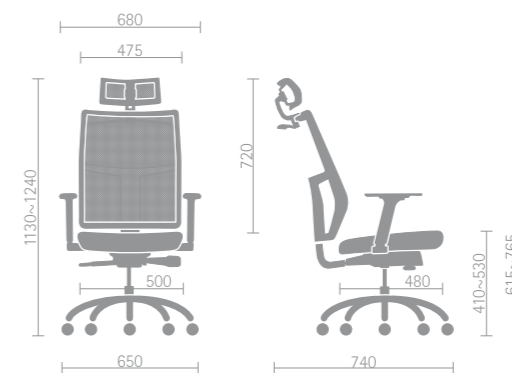

S:ITZ

AIRYS



S:ITZ





**AIRYS**  
DESCRIÇÕES

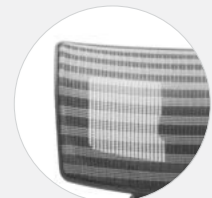

1. Encosto de cabeça articulado, elaborado em PP com tela ou estofado.

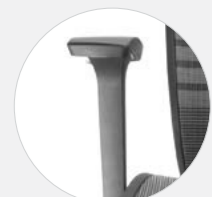

3. Braço com regulagem de altura em múltiplos pontos e deslizamento do apoio em PU.



5. Assento em tela ou estofado.



7. Base em Nylon com design piramidal.

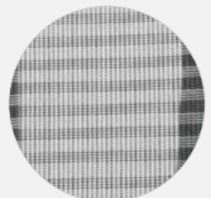

2. Encosto e assento em tela, que permite troca térmica.

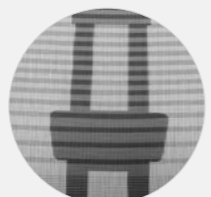

4. Ajuste lombar para o encosto.



6. Mecanismo Sincron com múltiplos pontos de parada, que permite o deslizamento do assento, regulagem da profundidade e ajuste de tensão.

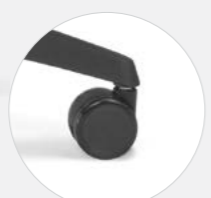

8. Rodízio em PU ou Nylon.



**APOIO**



Encosto cabeça - Tela



Encostocabeça- Revestido



**ASSENTO**



Assento - Tela



Assento - Revestido

**MECANISMO**



Mecanismo

**BRAÇO**



Braço para PO - Tela



Braço para PO- Revestida

**BASE**



Base em Nylon

**COMPONENTES AIRYS**

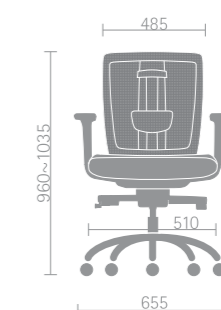
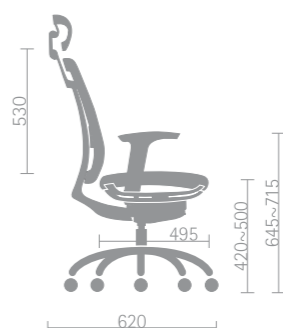
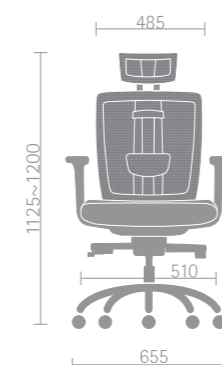
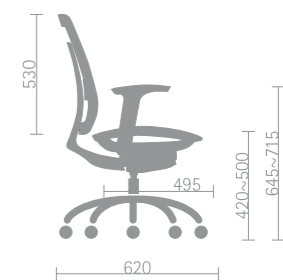
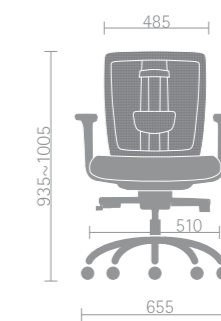
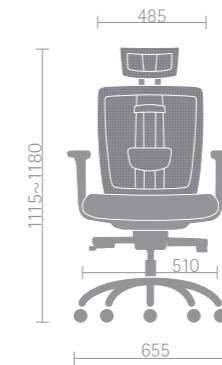

S:ITZ

FIT



S:ITZ



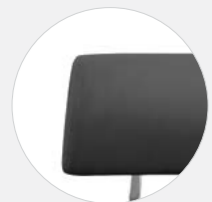

1. Encosto de cabeça tapeçado articulado.

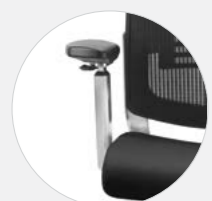

3. Braço com regulagem de altura em múltiplos pontos e apoio com ajuste angular em PU.

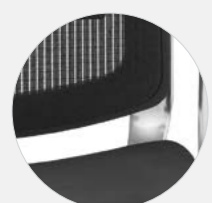

5. Suporte de fixação do encosto, em alumínio.

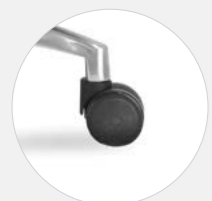

7. Rodízio em Nylon.

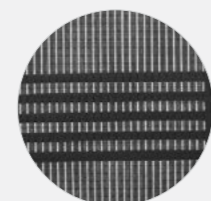

2. Encosto em tela com ajuste lombar, ou estofado sem ajuste.

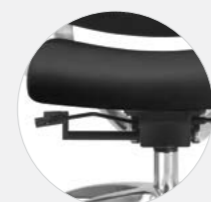

4. Mecanismo Sincron com múltiplos pontos de parada, deslizamento de assento, regulagem da profundidade e ajuste de tensão.



6. Base arcada em alumínio

**FIT**

**DESCRIÇÕES**



**APOIO**



Opção quando é Tela



Opção quando é Revestida

**ENCOSTO**



Encosto em Tela

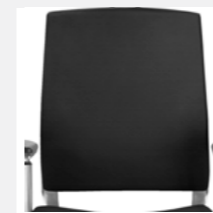

Encosto Revestido

**MECANISMO**



Mecanismo

**BRAÇO**



Braço para PO - Tela

**BASE**



Base em Alumínio

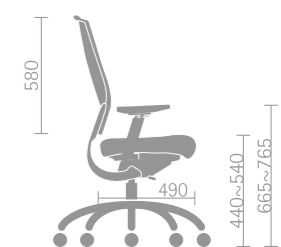
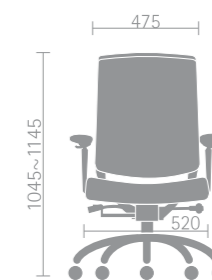
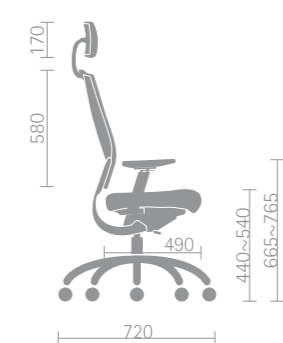
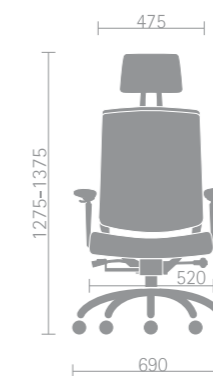
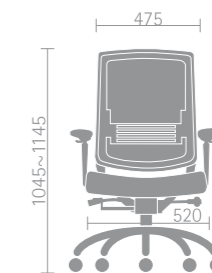
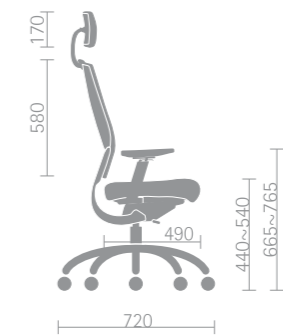
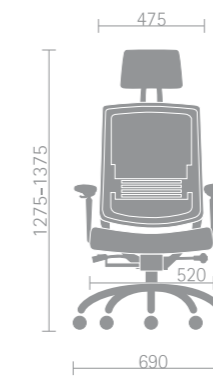

Medidas nominais para referência, podem ocorrer variações.



ANTIQUE  
LIMITED EDITION  
VECTOR EPS 10  
S:ITZ  
LINE ART  
EST.1960



# QUADRY

S:ITZ

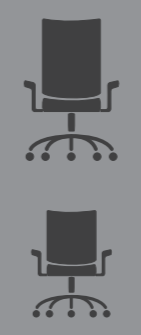

**QUADRY**  
DESCRIÇÕES



1. Encosto em espuma injetada com percintas elásticas e revestido.



2. Assento em espuma injetada revestida.



3. Braço com ajuste de altura, múltiplos pontos de parada e apoio em PU.



4 Mecanismo Synchron com 4 estágios de parada e sistema de tensão autoajustável.



5 Base em Nylon ou Alumínio com design piramidal.



6. Rodízio em PU ou Nylon.

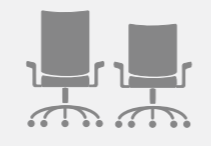

<b>BASE</b>		
	Basepiramidal-Alumínio	Base piramidal - Nylon
<b>MECANISMO</b>		
	Mecanismo Synchron-auto	Mecanismo Deslizante
<b>BRAÇO</b>		
	Braço com regulagem-PP	Braço com regulagem-PP
<b>RODÍZIO</b>		
	Rodízio - Nylon	Rodízio - PU

COMPONENTES QUADRY

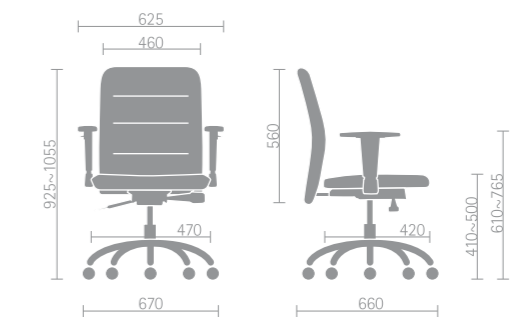
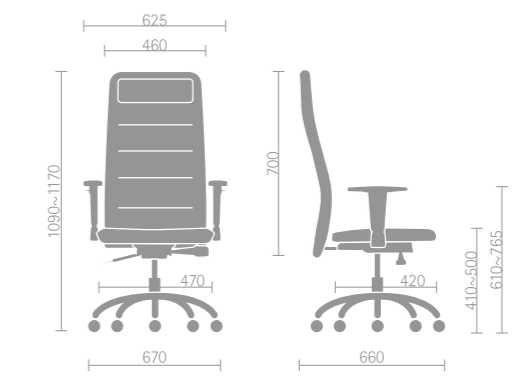

Medidas nominais para referência, podem ocorrer variações.

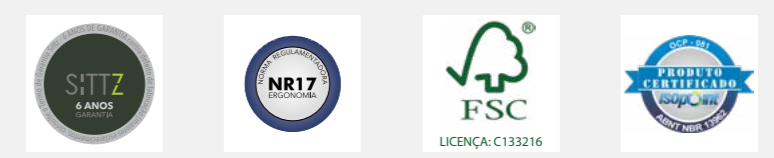

SITZ

[contato@sitz.com.br](mailto:contato@sitz.com.br)  
[www.sitz.com.br](http://www.sitz.com.br)