

TRIACS

Glass-passivated 8 ampere triacs intended for use in applications requiring high bidirectional transient and blocking voltage capability and high thermal cycling performance with very low thermal resistances. These triacs feature a high surge current capability and a range of gate current sensitivities between 5 and 50 mA. Typical applications include AC power control circuits such as motor, industrial lighting, industrial and domestic heating control and static switching systems.

QUICK REFERENCE DATA

		BT137-500			600	800	
Repetitive peak off-state voltage	V_{DRM}	max.	500	600	800	V	
R.M.S. on-state current	$I_{T(RMS)}$	max.	8			A	
Non-repetitive peak on-state current	I_{TSM}	max.	55			A	

MECHANICAL DATA

Dimensions in mm

Fig.1 TO-220AB.

blue binder, tab 10

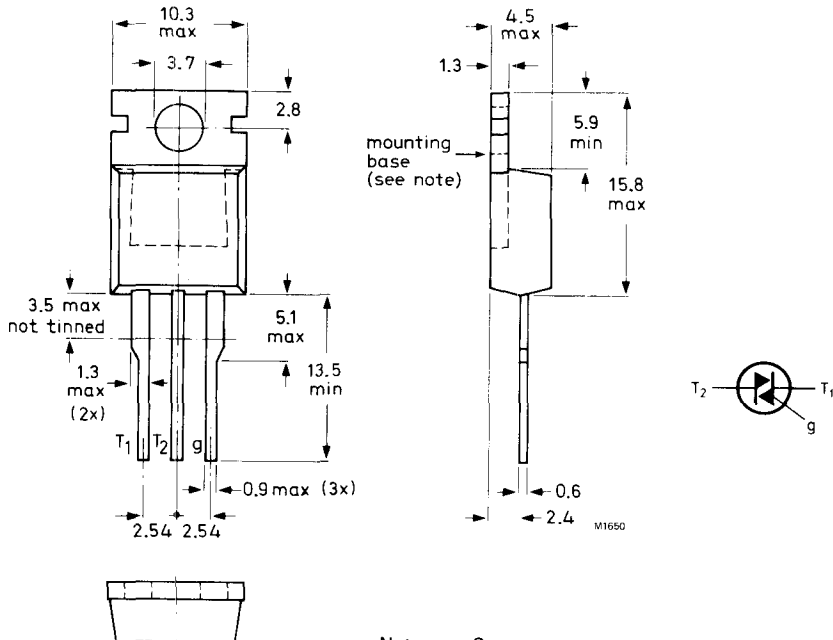

Net mass: 2 g

Note: The exposed metal mounting base is directly connected to terminal T₂.

Supplied on request: accessories (see data sheets Mounting instructions and accessories for TO-220 envelopes).



RATINGS

Limiting values in accordance with the Absolute Maximum System (IEC 134)

Voltages (in either direction)

		BT137-500	600	800	
→	Non-repetitive peak off-state voltage ($t \leq 10$ ms) †	V _{DSM}	max. 500*	600*	800 V
→	Repetitive peak off-state voltage ($\delta \leq 0.01$) †	V _{DRM}	max. 500	600	800 V
	Crest working off-state voltage	V _{DWM}	max. 400	400	400 V

Currents (in either direction)

R.M.S. on-state current (conduction angle 360°)
up to $T_{mb} = 97$ °C

I_{T(RMS)} max. 8 A

Repetitive peak on-state current

I_{TRM} max. 55 A

Non-repetitive peak on-state current;
 $T_j = 120$ °C prior to surge;
 $t = 20$ ms; full sine-wave

I_{TSM} max. 55 A

I²t for fusing ($t = 10$ ms)

I²t max. 15 A²s

Rate of rise of on-state current
after triggering with $I_G = 200$ mA to
 $I_T = 12$ A; $dI_G/dt = 0.2$ A/ μ s

dI_T/dt max. 20 A/ μ s

Gate to terminal 1

POWER DISSIPATION

Average power dissipation (averaged over
any 20 ms period)

P_{G(AV)} max. 0.5 W

Peak power dissipation

P_{GM} max. 5 W

Temperatures

Storage temperature

T_{stg} -40 to +125 °C

Operating junction temperature
full-cycle operation
half-cycle operation

T_j max. 120 °C
T_j max. 110 °C

† For BT137-500D/600D use $R_{(G-T_1)} = 1$ k Ω .

*Although not recommended, off-state voltages up to 800 V may be applied without damage, but the triac may switch into the on-state. The rate of rise of on-state current should not exceed 6 A/ μ s.

THERMAL RESISTANCE

From junction to mounting base

full-cycle operation

half-cycle operation

$R_{th\ j-mb} = 2.0\ K/W$

$R_{th\ j-mb} = 2.4\ K/W$

Transient thermal impedance; $t = 1\ ms$

$Z_{th\ j-mb} = 0.3\ K/W$

Influence of mounting method

1. Heatsink mounted with clip (see mounting instructions)

Thermal resistance from mounting base to heatsink

a. with heatsink compound

$R_{th\ mb-h} = 0.3\ K/W$

b. with heatsink compound and 0.06 mm maximum mica insulator

$R_{th\ mb-h} = 1.4\ K/W$

c. with heatsink compound and 0.1 mm max. mica insulator (56369)

$R_{th\ mb-h} = 2.2\ K/W$

d. with heatsink compound and 0.25 mm max. alumina insulator (56367)

$R_{th\ mb-h} = 0.8\ K/W$

e. without heatsink compound

$R_{th\ mb-h} = 1.4\ K/W$

2. Free-air operation

The quoted values of $R_{th\ j-a}$ should be used only when no leads of other dissipating components run to the same tie-point.Thermal resistance from junction to ambient in free air:
mounted on a printed-circuit board at any lead length

$R_{th\ j-a} = 60\ K/W$

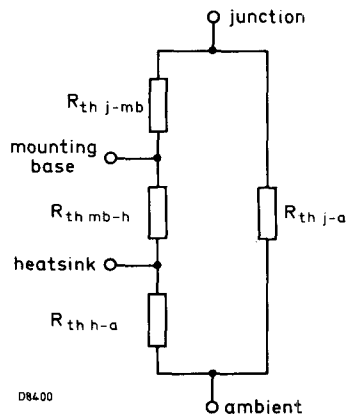

Fig.2 Components of thermal resistance.

CHARACTERISTICS ($T_j = 25\text{ }^\circ\text{C}$ unless otherwise stated)

Polarities, positive or negative, are identified with respect to T_1 .

Voltages and currents (in either direction)

On-state voltage (measured under pulse conditions to prevent excessive dissipation)

$$I_T = 10\text{ A} \qquad V_T < 1.65\text{ V}$$

Rate of rise of off-state voltage that will not trigger

any device; $T_j = 120\text{ }^\circ\text{C}$; gate open circuit

BT137 series	dV_D/dt	<	100	V/ μs
BT137 series G	dV_D/dt	<	200	V/ μs
BT137 series F	dV_D/dt	<	50	V/ μs
BT137 series E	dV_D/dt	typ.	50	V/ μs
BT137-500D/600D ($R_{(G-T_1)} = 1\text{ k}\Omega$)	dV_D/dt	typ.	5	V/ μs

Rate of change of commutating voltage that will not

trigger any device when $-di_{com}/dt = 3.6\text{ A/ms}$;

$I_T(\text{RMS}) = 8\text{ A}$; $T_{mb} = 70\text{ }^\circ\text{C}$; gate open circuit; $V_D = V_{DWMmax}$

BT137 series	dV_{com}/dt	typ.	10	V/ μs
BT137 series G	dV_{com}/dt	<	10	V/ μs
BT137 series F	dV_{com}/dt	typ.	10	V/ μs

Off-state current

$$V_D = V_{DWMmax}; T_j = 120\text{ }^\circ\text{C} \qquad I_D < 0.5\text{ mA}$$

Gate voltage that will trigger all devices

$$V_{GT} > 1.5\text{ V}$$

Gate voltage that will not trigger any device

$V_D = V_{DWMmax}$; $T_j = 120\text{ }^\circ\text{C}$;

T_2 and G positive or negative

$$V_{GD} < 250\text{ mV}$$

Gate current that will trigger all devices (I_{GT}); G to T_1

			T_2^+ G+	T_2^+ G-	T_2^- G-	T_2^- G+	
BT137 series	I_{GT}	>	35	35	35	70	mA
	I_H	<	20	20	20	20	mA
	I_L	<	30	45	30	45	mA
BT137 series G	I_{GT}	>	50	50	50	100	mA
	I_H	<	40	40	40	40	mA
	I_L	<	45	60	45	60	mA
BT137 series F	I_{GT}	>	25	25	25	70	mA
	I_H	<	20	20	20	20	mA
	I_L	<	30	45	30	45	mA
BT137 series E	I_{GT}	>	10	10	10	25	mA
	I_H	<	20	20	20	20	mA
	I_L	<	25	35	25	35	mA
BT137-500D/600D	I_{GT}	>	5	5	5	10	mA
	I_H	<	15	15	15	15	mA
	I_L	<	15	20	15	20	mA

MOUNTING INSTRUCTIONS

1. The device may be soldered directly into the circuit, but the maximum permissible temperature of the soldering iron or bath is 275 °C; it must not be in contact with the joint for more than 5 seconds. Soldered joints must be at least 4.7 mm from the seal.
2. The leads should not be bent less than 2.4 mm from the seal, and should be supported during bending. The leads can be bent, twisted or straightened by 90° maximum. The minimum bending radius is 1 mm.
3. It is recommended that the circuit connection be made to tag T₂, rather than direct to the heatsink.
4. Mounting by means of a spring clip is the best mounting method because it offers:
 - a. a good thermal contact under the crystal area and slightly lower R_{th mb-h} values than screw mounting.
 - b. safe isolation for mains operation.However, if a screw is used, it should be M3 cross-recess pan-head. Care should be taken to avoid damage to the plastic body.
5. For good thermal contact, heatsink compound should be used between mounting base and heatsink. Values of R_{th mb-h} given for mounting with heatsink compound refer to the use of a metallic-oxide loaded compound. Ordinary silicone grease is not recommended.
6. Rivet mounting (only possible for non-insulated mounting)
Devices may be rivetted to flat heatsinks; such a process must neither deform the mounting tab, nor enlarge the mounting hole. The maximum recommended hole size for rivet mounting is 3.5mm. The pre-formed head of the rivet should be on the device side and any rivet tool used should not damage the plastic body of the device.
7. The heatsink must have a flatness in the mounting area of 0.02 mm maximum per 10 mm. Mounting holes must be deburred.

FULL-CYCLE OPERATION

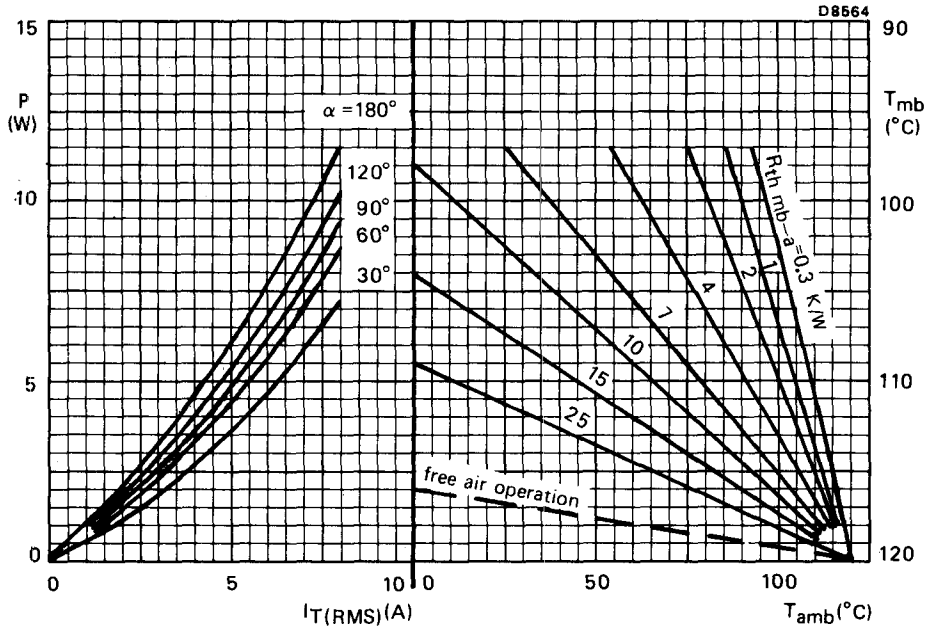
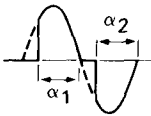

Fig.3 The right-hand part shows the interrelationship between the power (derived from the left-hand part) and the maximum permissible temperatures.



$\alpha = \alpha_1 = \alpha_2$: conduction angle per half cycle

OPERATING NOTES

Dissipation and heatsink considerations:

a. The method of using Fig.3 is as follows:

Starting with the required current on the I_{T(AV)} or I_{T(RMS)} axis, trace upwards to meet the appropriate form factor or conduction angle curve. Trace horizontally and upwards from the appropriate value on the T_{amb} scale. The intersection determines the R_{th mb-a}. The heatsink thermal resistance value (R_{th h-a}) can now be calculated from:

$$R_{th\ h-a} = R_{th\ mb-a} - R_{th\ mb-h}$$

b. Any measurement of heatsink temperature should be made immediately adjacent to the device.

OVERLOAD OPERATION

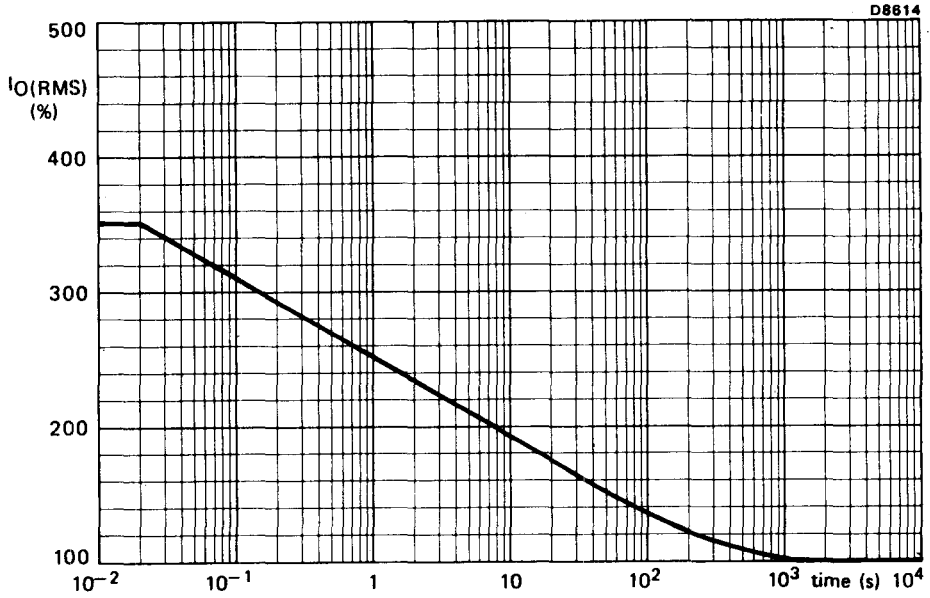

Fig.4 Maximum permissible duration of steady overload (provided that T_{mb} does not exceed $120\text{ }^{\circ}\text{C}$ during and after overload) expressed as a percentage of the steady state r.m.s. rated current. For high r.m.s. overload currents precautions should be taken so that the temperature of the terminals does not exceed $125\text{ }^{\circ}\text{C}$. During these overload conditions the triac may lose control. Therefore the overload should be terminated by a separate protection device.

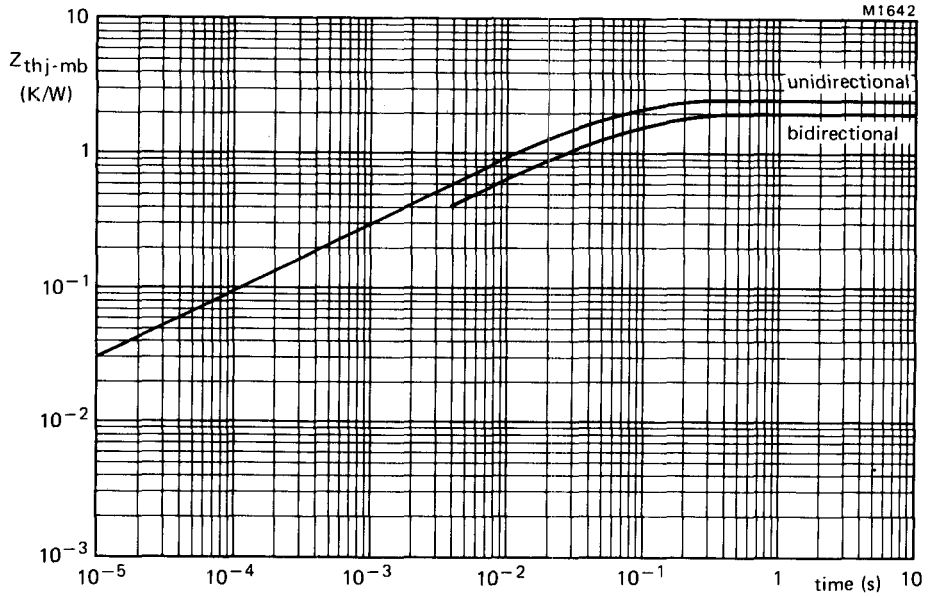

Fig.5 Thermal impedance as a function of dissipation time.

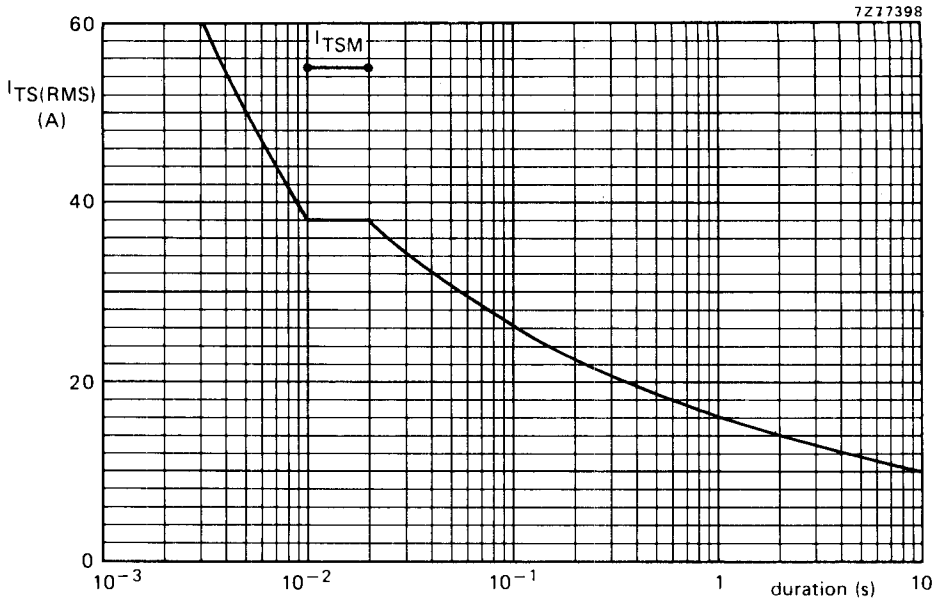

Fig.6 Maximum permissible non-repetitive r.m.s. on-state current based on sinusoidal currents ($f = 50 \text{ Hz}$); $T_j = 120 \text{ }^\circ\text{C}$ prior to surge. The triac may temporarily lose control following the surge.

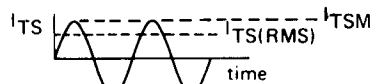
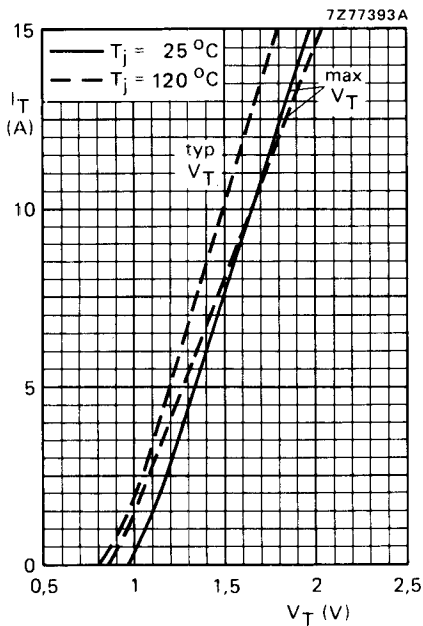

Fig.7 On-state voltage drop (V_T) versus on-state current (I_T).

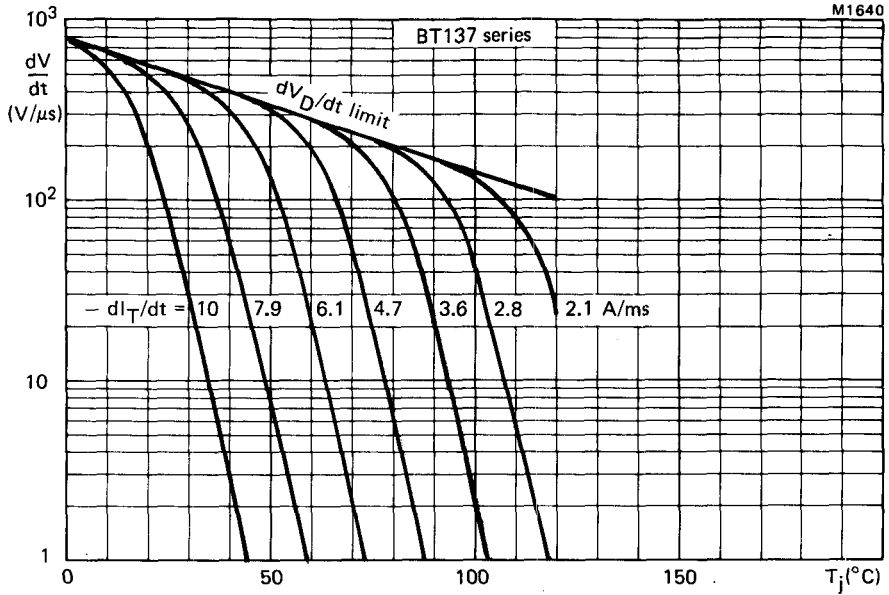

Fig.8 Typical commutation dV/dt for BT137 series versus T_j . The triac should commute when the dV/dt is below the value on the appropriate curve for pre-commutation di_T/dt .

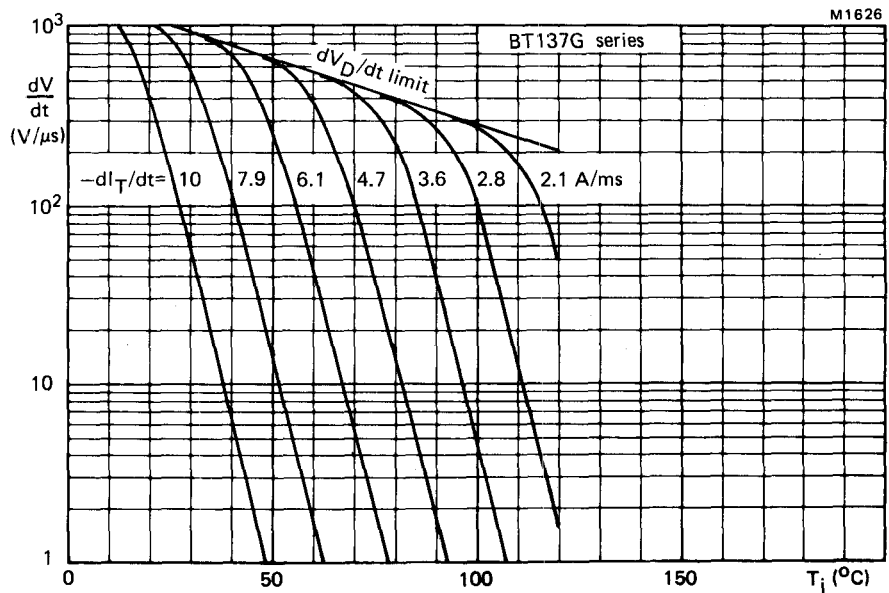

Fig.9 Limit commutation dV/dt for BT137G series versus T_j . The triac should commute when the dV/dt is below the value on the appropriate curve for pre-commutation di_T/dt .

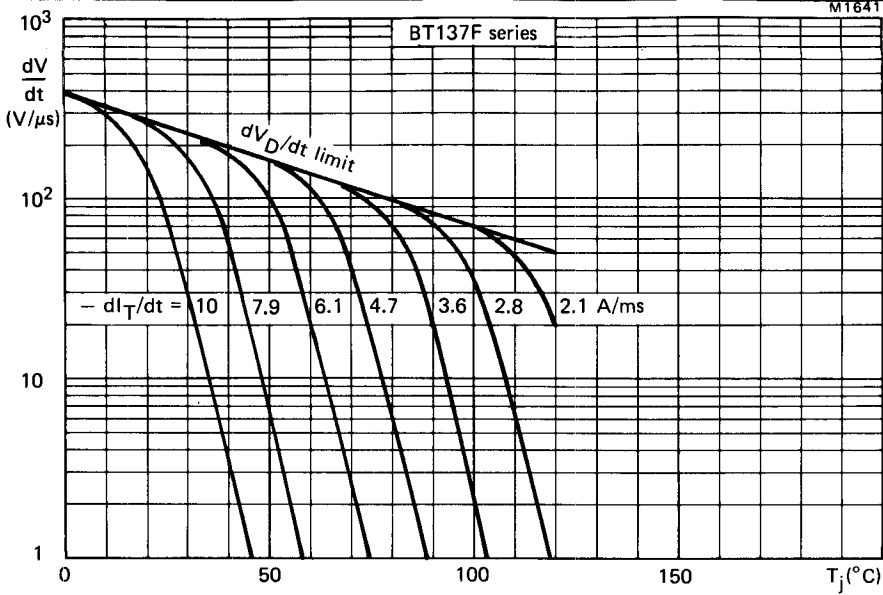

Fig.10 Typical commutation dV/dt for BT137F series versus T_j . The triac should commute when the dV/dt is below the value on the appropriate curve for pre-commutation di_T/dt .

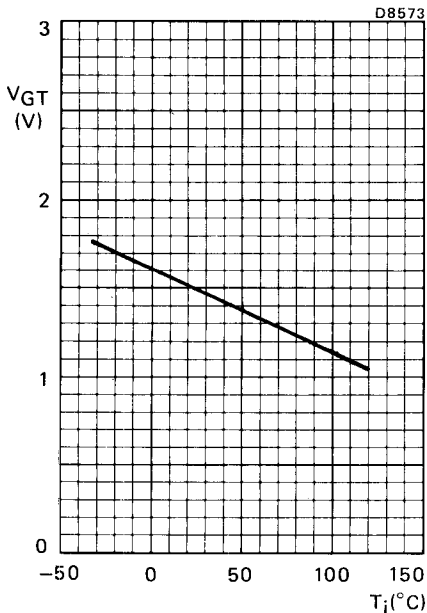

Fig.11 Minimum gate voltage that will trigger all devices; all conditions.

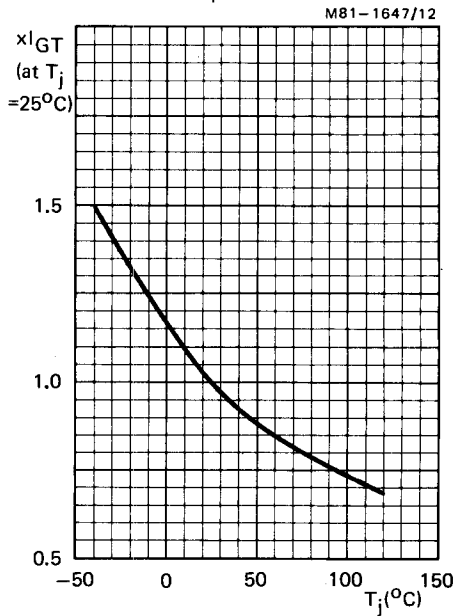

Fig.12 Normalised gate current that will trigger all devices; all conditions.