



POLICOMP
componentes industriais

HYBRID STEPPER MOTOR TYPE:

86HC97-5206A14-B35

SPECIFICATIONS				DIAGRAM
step angle	$1.2^\circ \pm 5\%$	current	5.2A	
phase No.	3	resistance	$1.2 \pm 10\% \Omega$	
insulation resistance	100M Ω m(500V DC)	inductance	$5.2 \pm 20\% \text{mH}$	
insulation class	B	holding torque	4.5N.m	

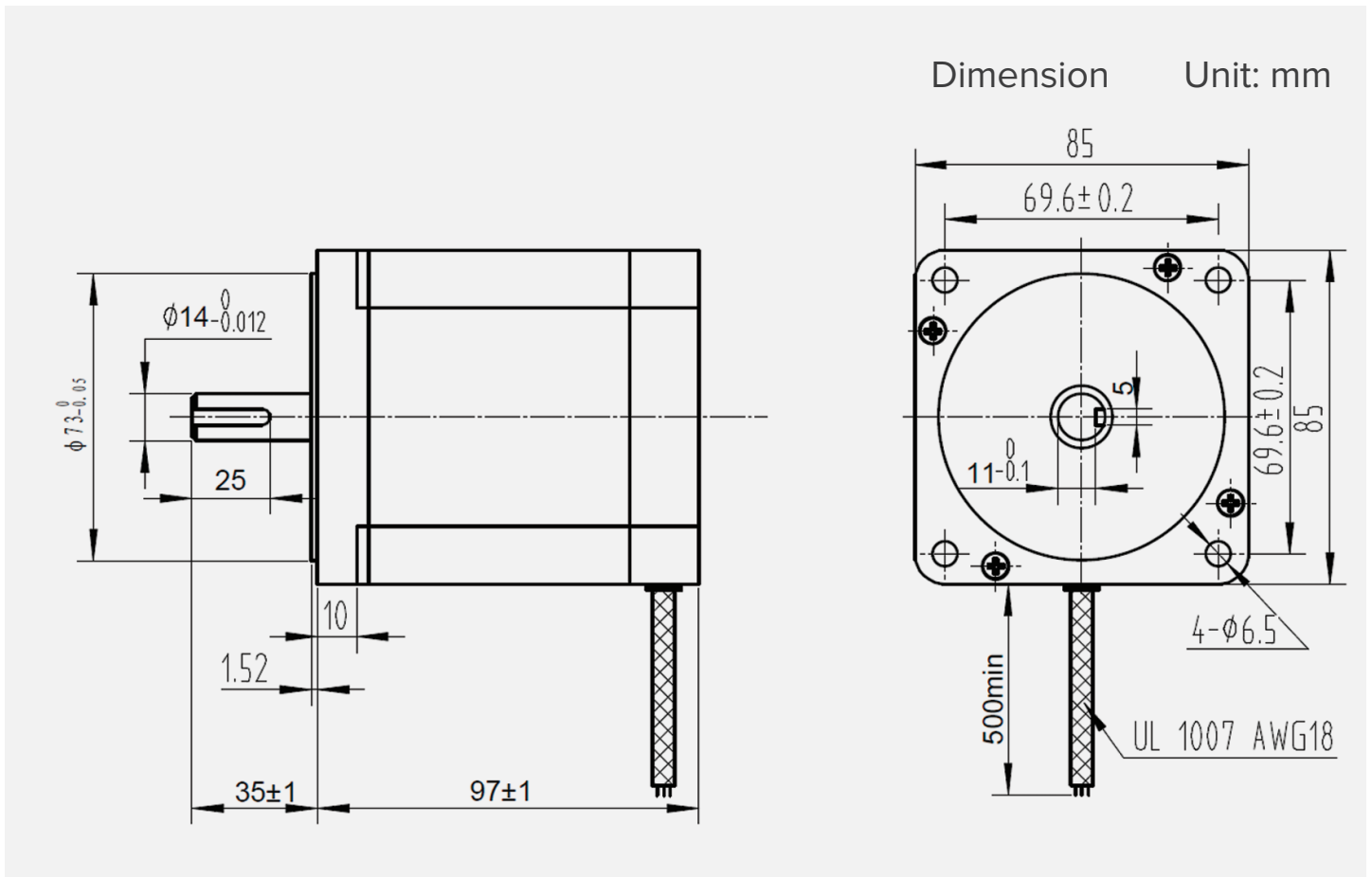

Design	Date	Check	Date	Approve	Date
--------	------	-------	------	---------	------



www.policompcomponentes.com.br
e-mail: vendas@policompcomponentes.com.br

11 5661-7579 /3368-4326

Rua Doutor Brasílio Machado
Neto, 103 - Vila Lisboa

CEP: 04776-133 - São Paulo/SP