

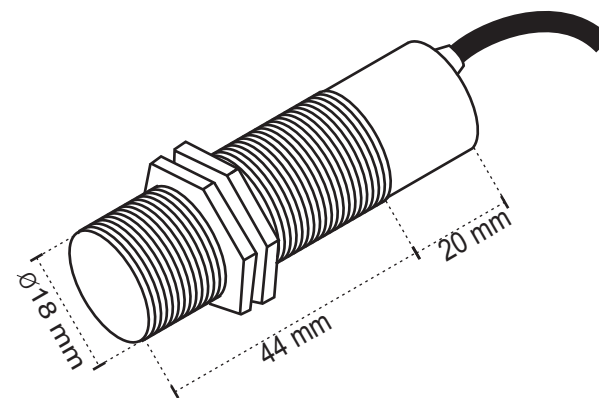

Sensor Indutivo

CP18 TY2 A H /GL - 5

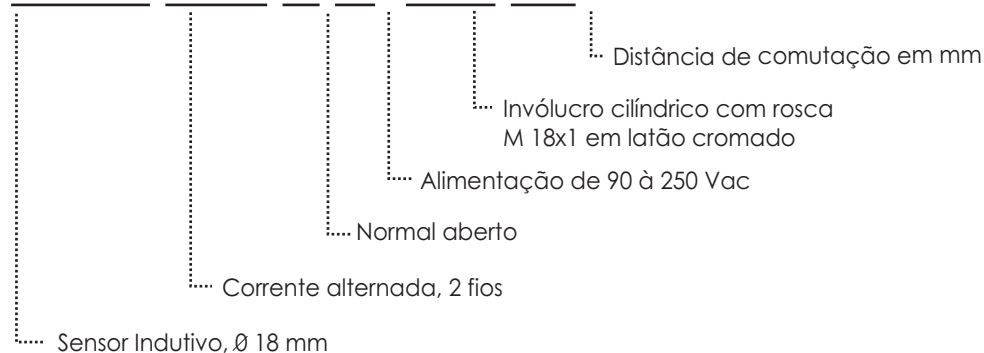

Máxima corrente de comutação: 200 mA

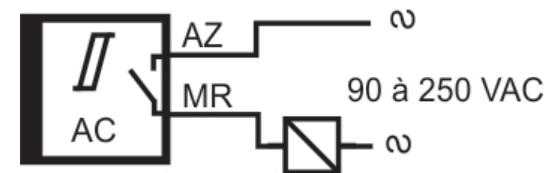

.: Atenção .:

Antes de energizar o sensor verificar se está ligado conforme o esquema acima.
O sensor deve estar ligado em série com a carga